

1. Features

- n $R_{DS(ON)}=1.6\Omega(\text{typ.})@V_{GS}=10V$
- n RoHS Compliant
- n Low Gate Charge Minimize Switching Loss
- n Fast Recovery Body Diode

2. Applications

- n Adaptor
- n Charger
- n SMPS Standby Power

3. Symbol

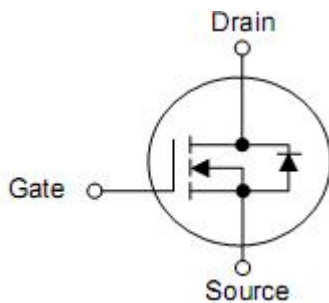
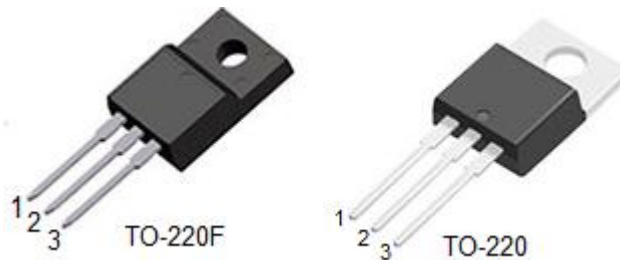

Pin	Function
1	Gate
2	Drain
3	Source

4. Ordering Information

Part Number	Package	Brand
KNF4590A	TO-220F	KIA
KNP4590A	TO-220	KIA

5. Absolute maximum ratings

$T_C=25^{\circ}\text{C}$ unless otherwise noted

Parameter	Symbol	Rating		Units	
		TO-220F	TO-220		
Drain-source voltage	V_{DSS}	900		V	
Gate-to-Source Voltage	V_{GSS}	± 30		V	
Continuous drain current	I_D	6		A	
Pulsed Drain Current at $V_{GS}=10\text{V}$	I_{DM}	24		A	
Single pulse avalanche energy	E_{AS}	700		mJ	
Power dissipation	P_D	$T_C=25^{\circ}\text{C}$	45	120	W
		Derate above 25°C	0.29	0.96	W/ $^{\circ}\text{C}$
Soldering Temperature Distance of 1.6mm from case for 10 seconds	T_L	300		$^{\circ}\text{C}$	
Operating junction and storage temperature range	T_J, T_{STG}	-55 to 150		$^{\circ}\text{C}$	

Caution: Stresses greater than those listed in the “Absolute Maximum Ratings” may cause permanent damage to the device.

6. Thermal characteristics

Parameter	Symbol	Rating		Unit
		TO-220F	TO-220	
Thermal resistance junction-case	$R_{\theta JC}$	2.78	1.04	$^{\circ}\text{C}/\text{W}$
Thermal Resistance, Junction-to-Ambient	$R_{\theta JA}$	100	62	$^{\circ}\text{C}/\text{W}$

7. Electrical characteristics

(T_J=25°C unless otherwise noted)

Parameter	Symbol	Test Conditions	Min	Typ	Max	Units
Drain-source breakdown voltage	BV _{DSS}	V _{GS} =0V, I _D =250uA	900	-	-	V
Drain-source leakage current	I _{DSS}	V _{DS} =900V, V _{GS} =0V	-	-	1	uA
		V _{DS} =720V, T _J =125°C	-	-	100	uA
Gate-source forward leakage	I _{GSS}	V _{GS} =±30V, V _{DS} =0V	-	-	±100	nA
Drain-source on-resistance	R _{DS(on)}	V _{GS} =10V, I _D =3A	-	1.6	2.0	Ω
Gate threshold voltage	V _{GS(TH)}	V _{DS} =V _{GS} , I _D =250uA	3.0	-	5.0	V
Forward Transconductance	g _{fs}	V _{DS} =15V, I _D =3A	-	8.0	-	S
Input capacitance	C _{iss}	V _{DS} =25V, V _{GS} =0V f=1MHz	-	1462	-	pF
Reverse transfer capacitance	C _{rss}		-	24	-	pF
Output capacitance	C _{oss}		-	132	-	pF
Total gate charge(10V)	Q _g	V _{DD} =450V, I _D =6A V _{GS} =0~10V	-	38	-	nC
Gate-source charge	Q _{gs}		-	8.1	-	nC
Gate-drain charge	Q _{gd}		-	15	-	nC
Turn-on delay time	t _{d(on)}	V _{DD} =450V, V _{GS} =10V, R _G =9.1Ω, I _D =6A		23		ns
Rise time	t _r			46		ns
Turn-off delay time	t _{d(off)}			32		ns
Fall time	t _f			38		ns
Continuous Source Current ²⁾	I _{SD}	Integral PN-diode in MOSFET			6	A
Pulsed Source Current ²⁾	I _{SM}		-	-	24	A
Diode forward voltage	V _{SD}	I _S =6A, V _{GS} =0V,	-	-	1.5	V
Reverse Recovery Time	t _{rr}	V _{GS} =0V, I _F =I _S dI _F /dt=100A/μs	-	390	-	nS
Reverse Recovery Charge	Q _{rr}		-	1.4	-	nC

Note:

1) T_J=+25 °C to +150 °C

2) Pulse width≤380us; duty cycle≤2%.

8. Typical operating characteristics

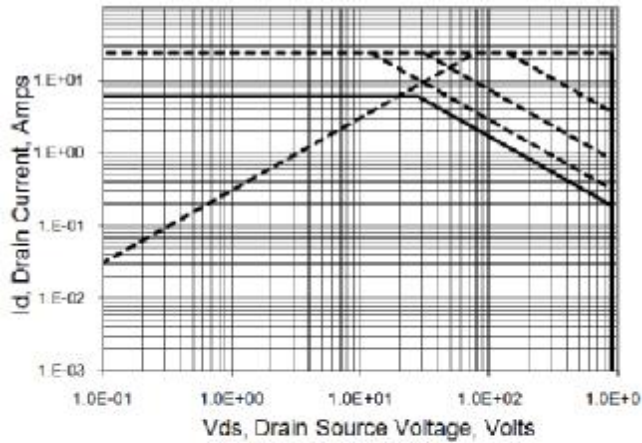

Figure 1 . Maximum Safe Operating Area

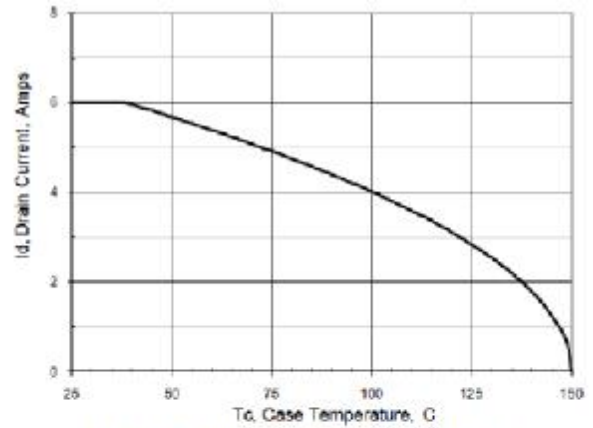

Figure 2 .Maximum Continuous Drain Current vs Case Temperature

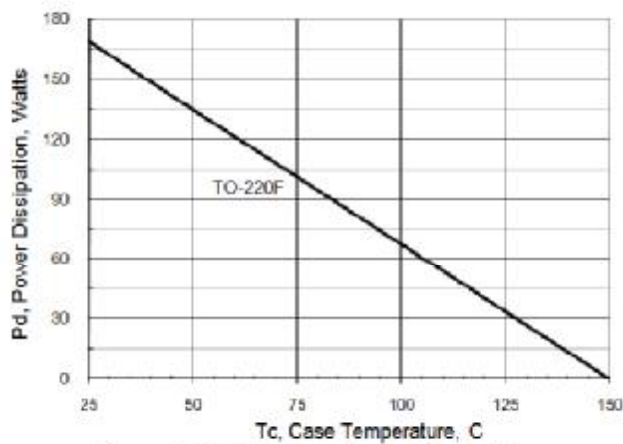

Figure 3.1 . Maximum Power Dissipation vs Case Temperature

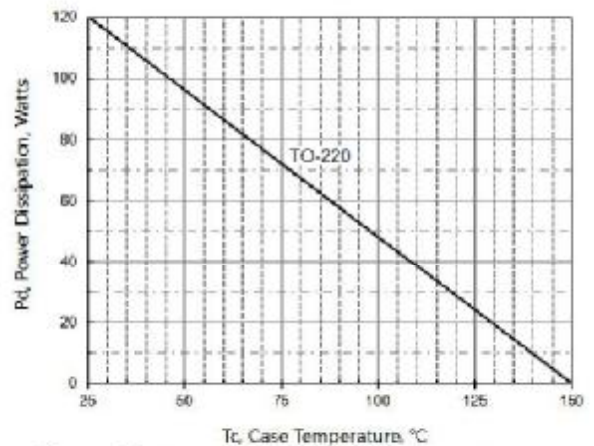

Figure 3.2. Max. Power Dissipation vs Case Temperature

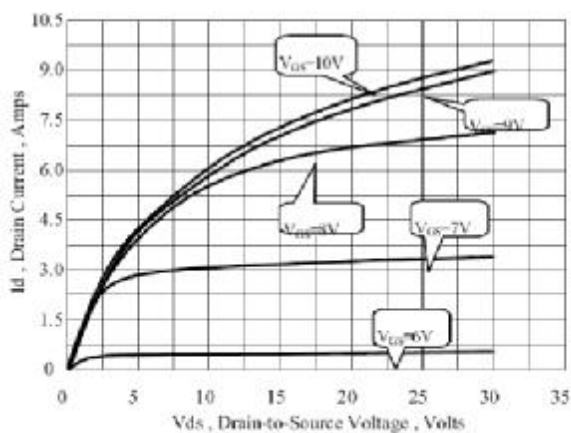

Figure 4 Typical Output Characteristics

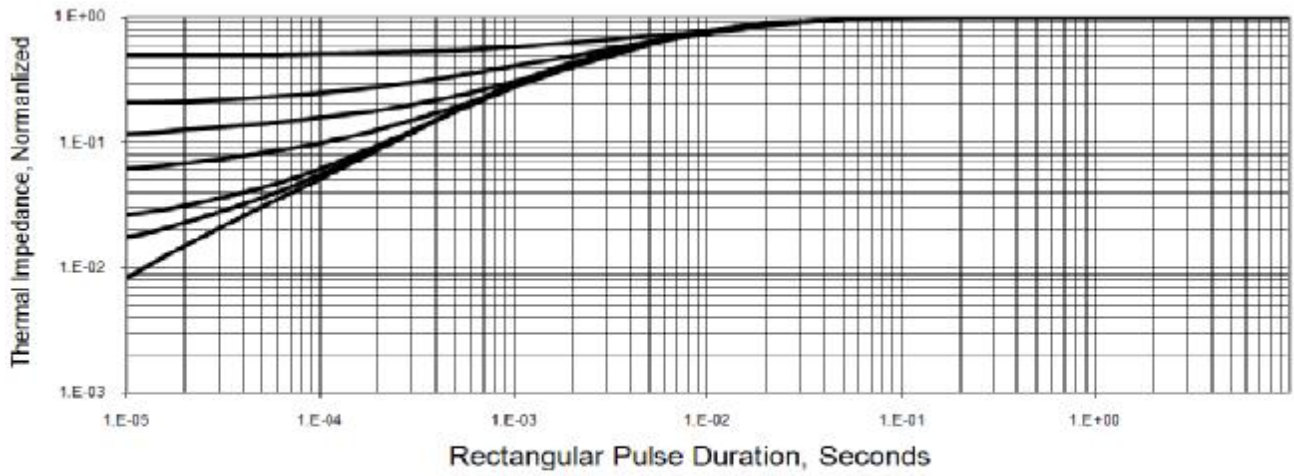

Figure 5. Maximum Transient Thermal Impedance

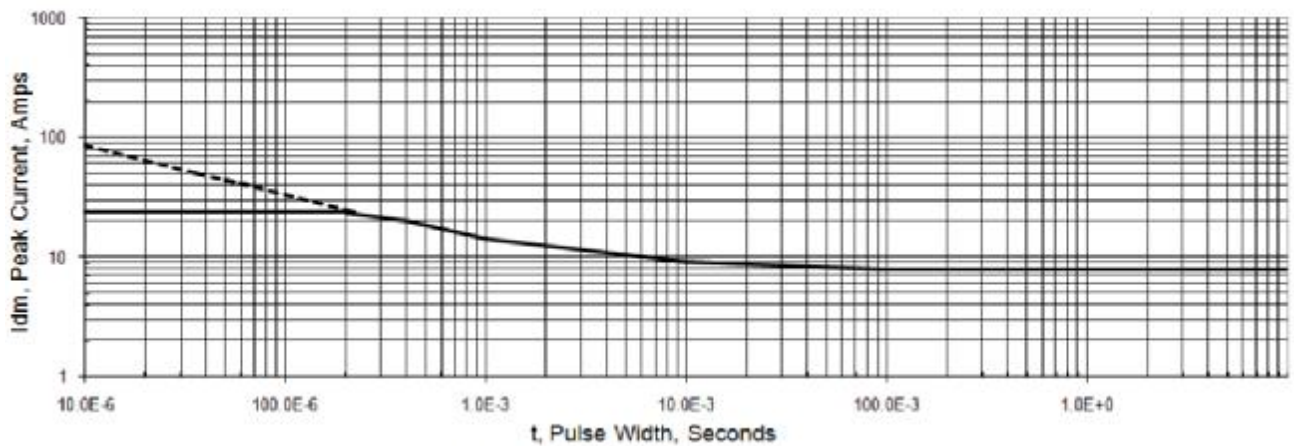

Figure 6. Peak Current Capability

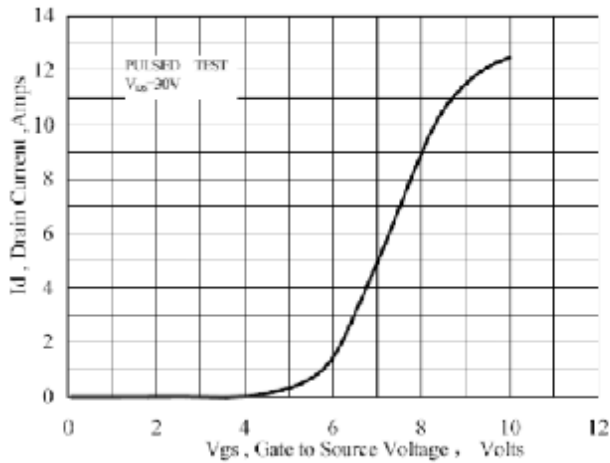

Figure 7 Typical Transfer Characteristics

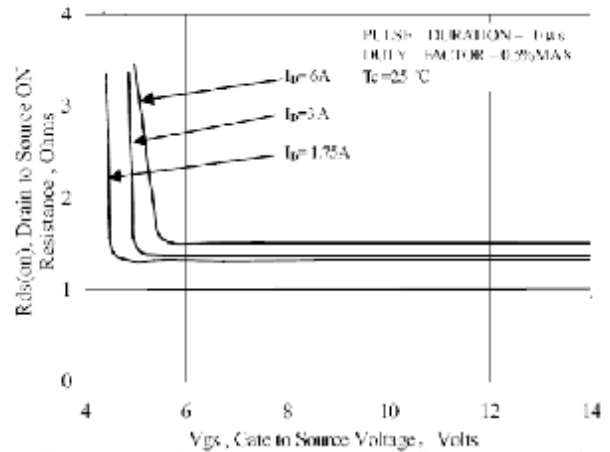

Figure 8 Typical Drain to Source ON Resistance vs Gate Voltage and Drain Current

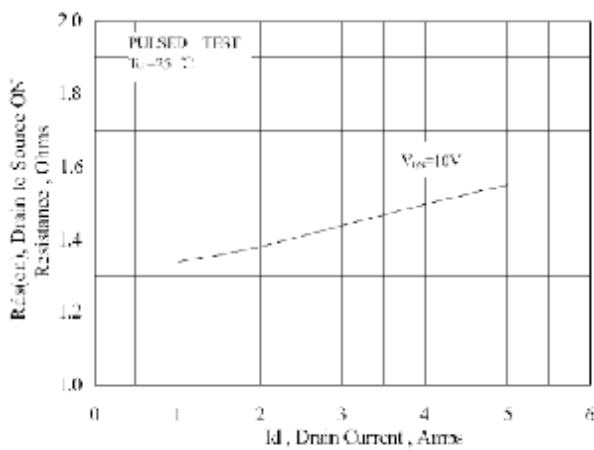

Figure 9 Typical Drain to Source ON Resistance vs Drain Current

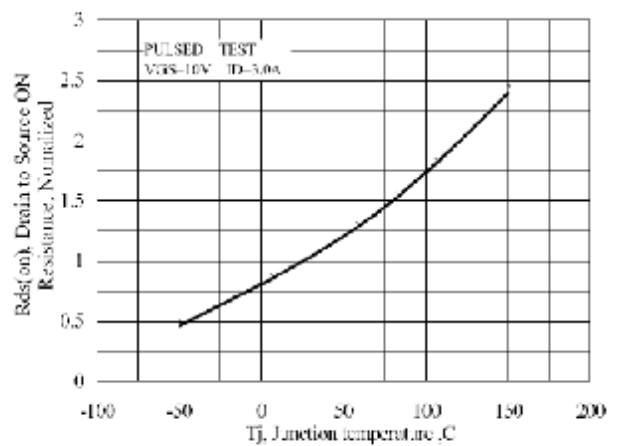

Figure 10 Typical Drain to Source on Resistance vs Junction Temperature

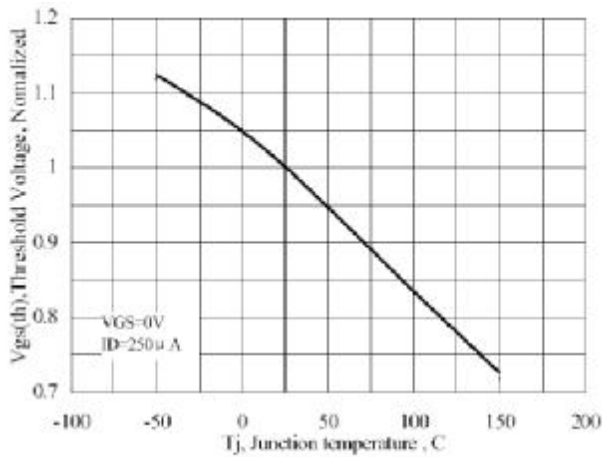

Figure 11 Typical Threshold Voltage vs Junction Temperature

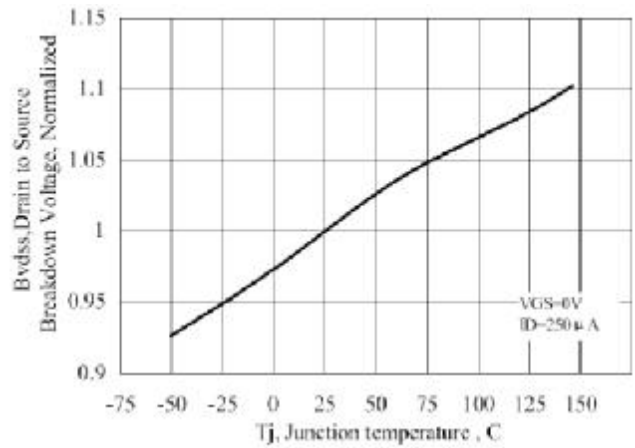

Figure 12 Typical Breakdown Voltage vs Junction Temperature

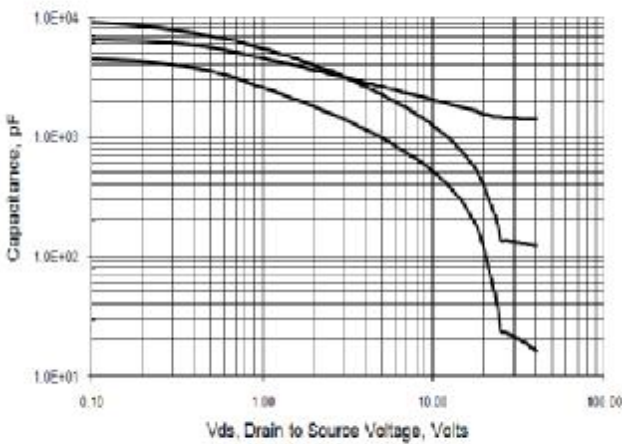

Figure 13. Capacitance vs Vds

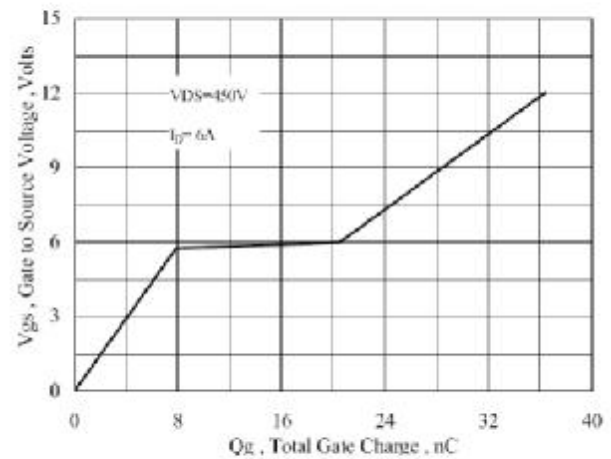

Figure 14 Typical Gate Charge vs Gate to Source Voltage

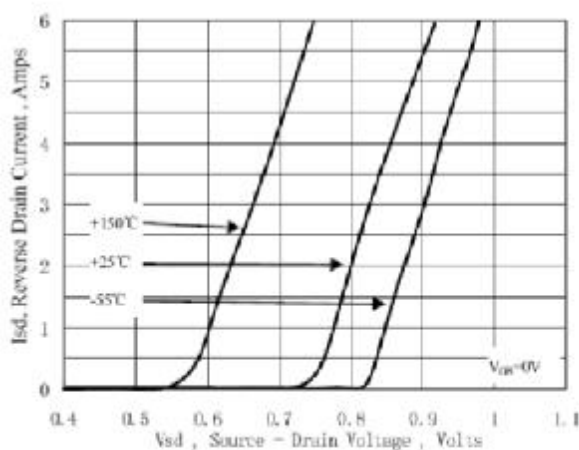

Figure 15 Typical Body Diode Transfer Characteristics

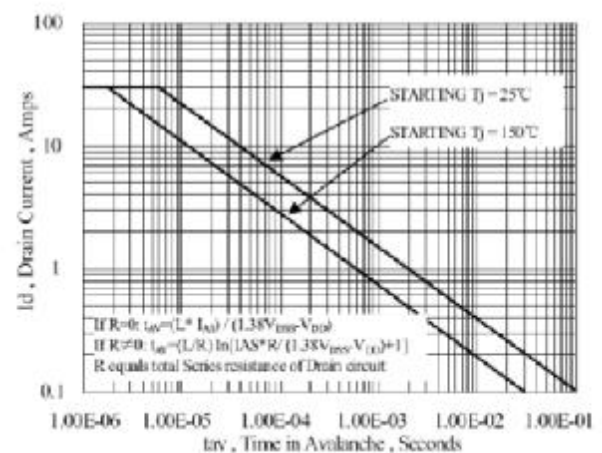

Figure 16 Unclamped Inductive Switching Capability

9. Test Circuits and Waveforms

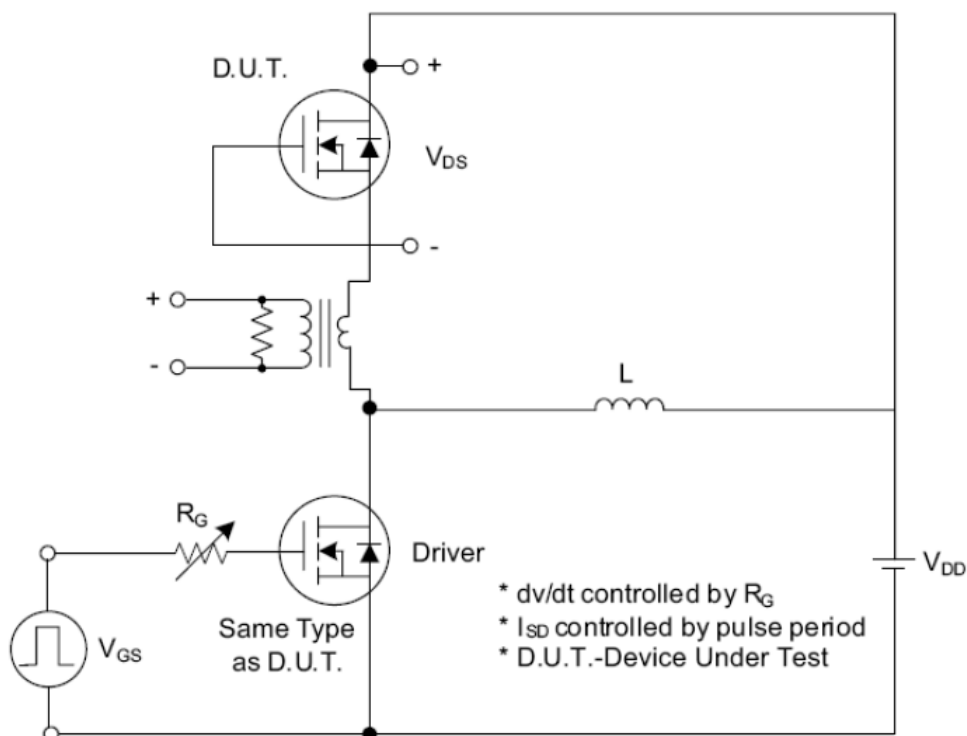

Fig. 1.1 Peak Diode Recovery dv/dt Test Circuit

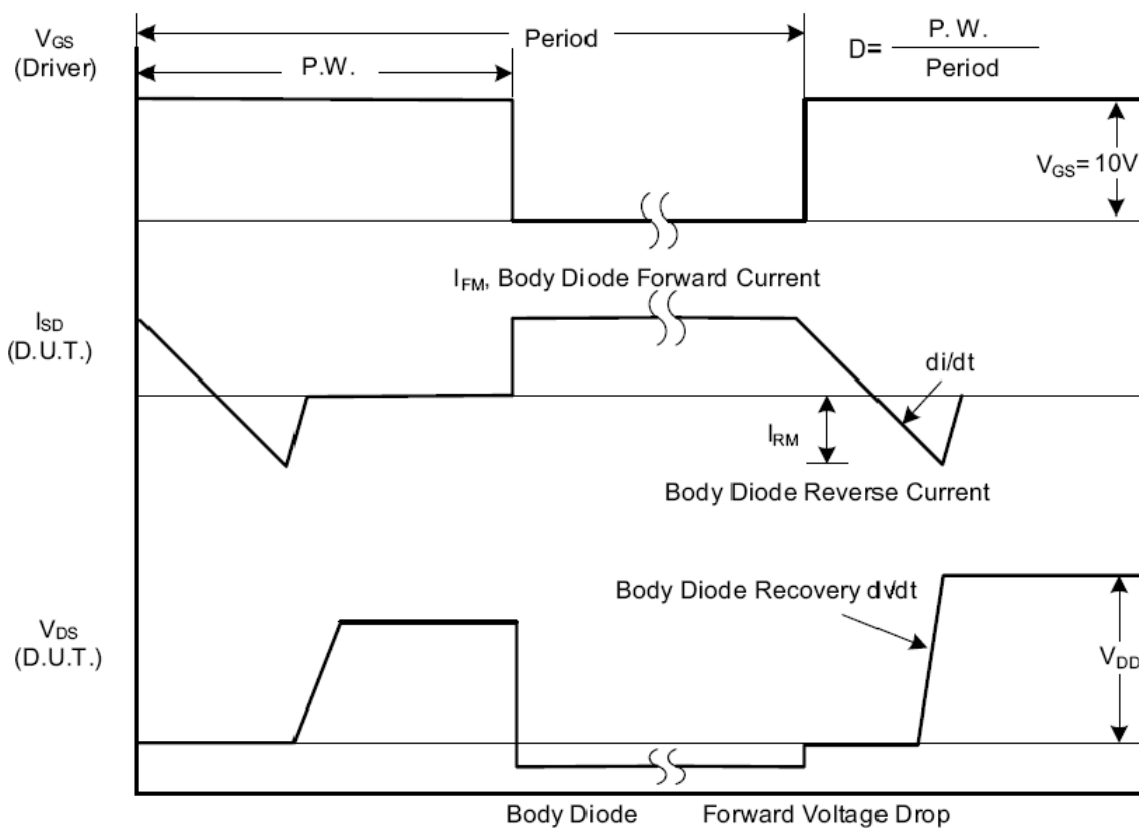

Fig. 1.2 Peak Diode Recovery dv/dt Waveforms

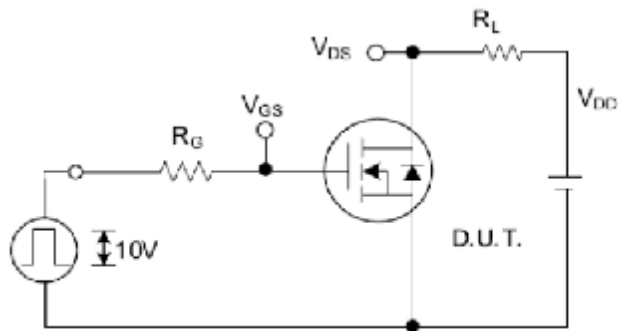

Fig. 2.1 Switching Test Circuit

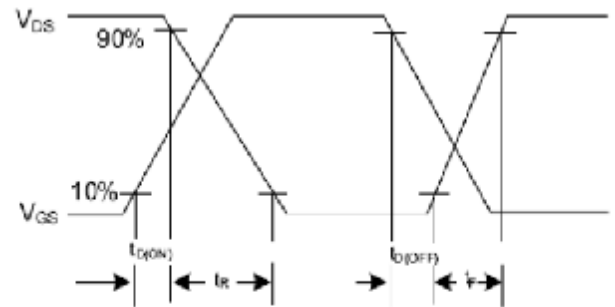

Fig. 2.2 Switching Waveforms

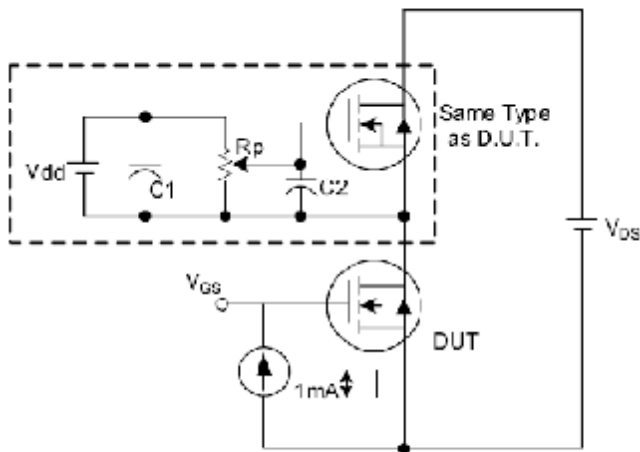

Fig. 3.1 Gate Charge Test Circuit

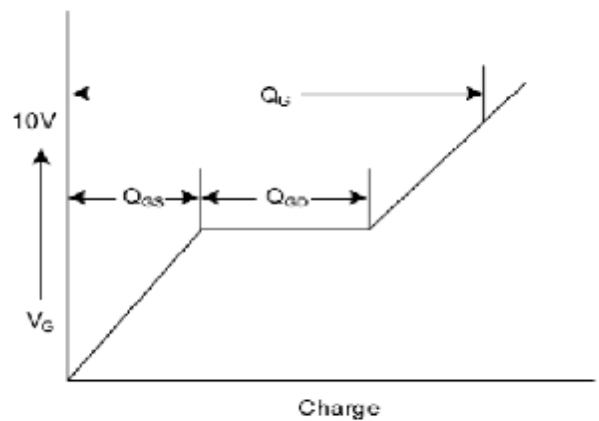

Fig. 3.2 Gate Charge Waveform

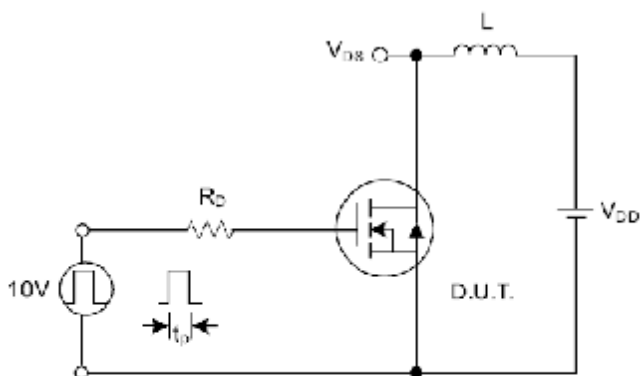

Fig. 4.1 Unclamped Inductive Switching Test Circuit

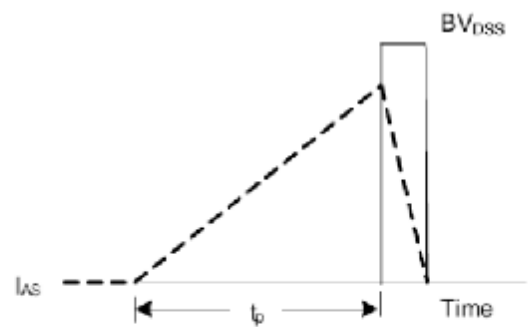

Fig. 4.2 Unclamped Inductive Switching Waveforms